

# DN91

## Synchronous rectification improves set top box power supply efficiency

Yong Ang, Diodes Incorporated

### Introduction

This design note describes the implementation of synchronous rectification on multiple-output flyback converters. It is focused on the low side rectification approach as shown in Figure 1 to facilitate a common drive for synchronous MOSFETs on low voltage 3.3 and 5V outputs. The note concludes with practical measurement on a 27W four-output set top box power supply to demonstrate that a 3% efficiency improvement over a Schottky solution can be achieved with the aid of the ZXGD3101 synchronous MOSFET controller.

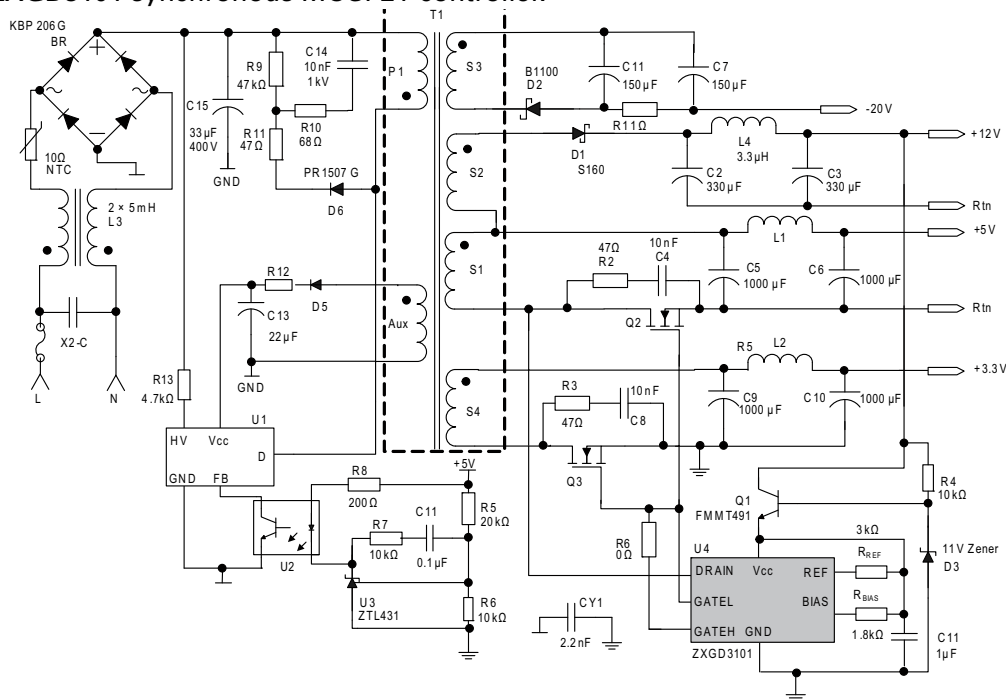

Figure 1 - Flyback converter with synchronous rectification on 5V and 3.3V output

### General description

Figure 2 shows a typical set top box power supply. It is a cost effective design with minimum component count. The circuit is designed to operate in Discontinuous Conduction Mode ('DCM') because there are lower switching losses. Furthermore, the flyback transformer size can be reduced owing to the lower average energy storage whilst its smaller magnetizing inductance also yields a better transient line/load response.

The primary stage is built around a monolithic high voltage current mode control IC, U1 running at a fixed frequency of 50kHz. The secondaries of the transformer are rectified and filtered by D1, C2, D2, C5, D3, C7, D4 and C9 to produce four outputs - +5V, +3.3V, +12V and -20V, where the +5V



end product. This design note therefore examines the implementation of synchronous rectification on these outputs.

More recently single output flyback has also been suggested for set top boxes. This approach derives the low voltage 3.3V and 5V outputs from the main 12V flyback output through synchronous or asynchronous buck post regulators. Although this simplifies the transformer design and eliminates cross regulation issues, it incurs a higher BOM cost, component count and possibly lower efficiency due to additional power loss in the post regulators. For information on synchronous rectification on single output flyback refer to AN54.

### Secondary side synchronous rectification approach

High-side synchronous rectification is not considered here as a common drive circuit controlling a MOSFETs on each of the 5V and 3.3V outputs is not possible. For high side, a separate controller on each output is required. The overall solution BOM component count and cost will be prohibitive for a low power set top box.

Figure 1 shows a design where two MOSFETs are driven by a single ZXGD3101 Synchronous MOSFET controller. Low side rectification positions Q2 and Q3 on the ground return of the 5V and 3.3V outputs respectively. This enables the MOSFETs to be driven by a common controller because Q2 and Q3 share a common source point. The controller will derive its supply from the 12V output via an emitter-follower transistor Q1.  $R_{REF}$  and  $R_{BIAS}$  are chosen to be 3k $\Omega$  and 1.8k $\Omega$  to set the controller turn-off threshold value to -20mV.

Either Q2 or Q3 can be the 'Control' MOSFET, whose Drain terminal signal needs be fed back to the 'Drain' pin of the ZXGD3101. In the design shown in Figure 1, Q2 is selected to be the 'Control' FET because the 5V output has a higher load current; therefore the Q2's peak current will be higher than that of Q3. The controller monitors Q2's Drain voltage for body diode conduction and then turns on the MOSFET. The same gate voltage also drives Q3 on the 3.3V output, though the gate voltage level is entirely independent of its current status.

The 'Control' MOSFET should ideally be the MOSFET that carries the highest current so that the controller produces a sufficient gate voltage to minimize conduction loss. The gate voltage output from the controller is proportional to Q2's Drain voltage during MOSFET on time. Furthermore, Q2 will also carry the current that flows through D1 on the 12V output as well as supplying the 5V output due to the stacked winding design. This puts additional current stress on the MOSFET.

The sink and source current from the controller is used to drive both synchronous MOSFETs. The switching time of Q2 and Q3 depends on their respective gate charge value. The controller turns these MOSFETs off without reverse current flow in DCM. More care has to be taken using the proposed configuration in a Continuous Conduction Mode ('CCM') converter to ensure that the secondary side switches are turned off safely without imposing huge current stress on the primary switch. This is because the increased likelihood of shoot through current occurring when switching off the large current in a CCM converter as the available sink current is now shared by Q2 and Q3.

### Evaluation of results

Laboratory evaluation was conducted on a 27W set top box power supply to assess the performance benefits of synchronous rectification. Set top box power supplies are typically minimally designed and usually have efficiency around 75% with diode rectification which results in hot internal component operation.

Although different types of MOSFETs could be selected for Q2 and Q3 based on their breakdown voltage and Drain current requirement, a common part is used in this design because the 5V and 3.3V output have fairly similar load current. Based on the current level through Q2, a 16m $\Omega$ , 79A,

# DN91

82nC MOSFET was selected so that voltage-drop across the Drain-Source pins is within 50 to 100mV at the peak MOSFET current.

Figure 3 compares the performance of synchronous rectification against a YG81S04R Schottky Barrier diode at 230Vac input voltage. The results demonstrate that a set top box power supply can be designed with efficiencies approaching 80% utilizing low on-resistance MOSFETs with the ZXGD3101. Synchronous rectification is 1% more efficient than the Schottky diode at 25% loading and the efficiency improvement gradually increases until it yields 2.9% better efficiency at full load. For completeness, the power supply efficiency against supply voltage variation is shown in Figure 4. The efficiency of this solution could be further improved beyond 80% if a discrete high voltage transistor and PWM controller are used on the primary stage instead of the existing monolithic solution.

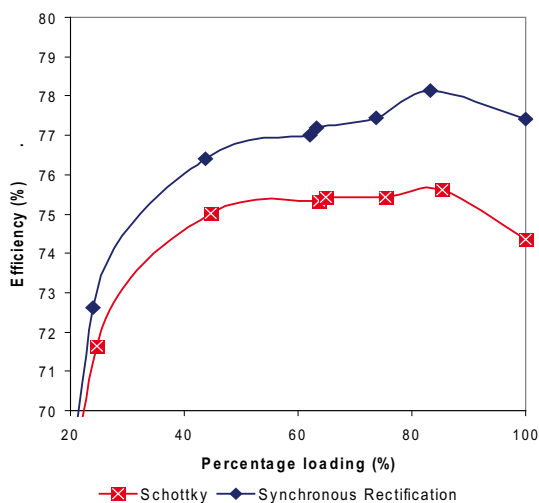

Figure 3 Efficiency vs. output loading, room temperature

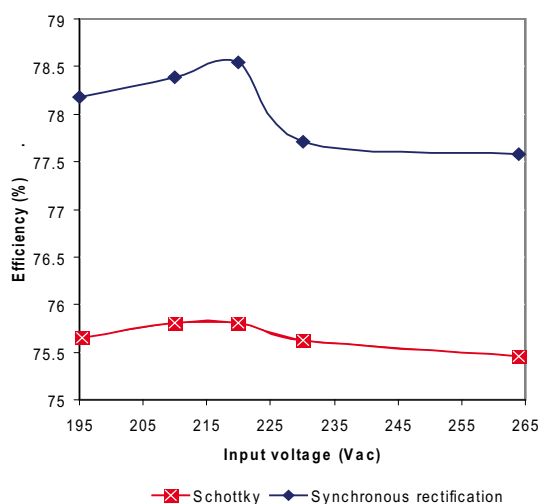
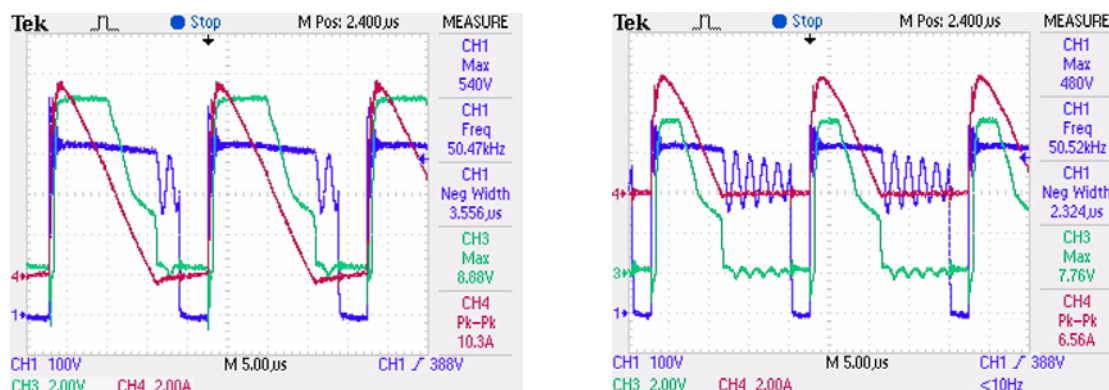

Figure 4 Set Top Box power supply efficiency vs. input voltage

Figure 5 shows the Gate voltage and Drain current waveforms of the 'Control' MOSFET at the maximum and minimum loading profile. In Figure 5(a), the Gate voltage reaches 8.5V to obtain a low MOSFET resistance at 100% loading. The Gate enhancement eases off gradually as the Drain current through the MOSFET decreases due to the ZXGD3101's proportional gate drive scheme. The controller reduces the Gate voltage magnitude as the MOSFET current decreases. Although this produces a larger on-state resistance, the subsequent increase in conduction voltage drop ensures that the controller maintains the gate voltage above 2-3V as the current decreases linearly down to zero. The MOSFET is driven off near the zero current point to ensure that there is no reverse current flowing through Q2.



(a) Maximum output power 31.7W

(b) Minimum output power 11.05W

**Figure 5 'Control' MOSFET current and voltage waveforms (CH1: Primary Drain voltage; CHx: Q2's Gate voltage; CH4: Q2's Drain current)**

Set top box power supplies normally have tracking between critical loads where the minimum and maximum loads on the +5V and +3.3V output occurs at the same time. In products where there is no tracking between outputs, the 3.3V load current could be minimum loaded whilst the 5V output is fully loaded. In that instance, Q2 will conduct a current a few times higher than that in Q3. As the Drain voltage level across the 'Control' MOSFET dictates that both Q2 and Q3 are kept on when Q2 is still conducting substantial current, even though the current in Q3 has reached zero as shown in Figure 6.

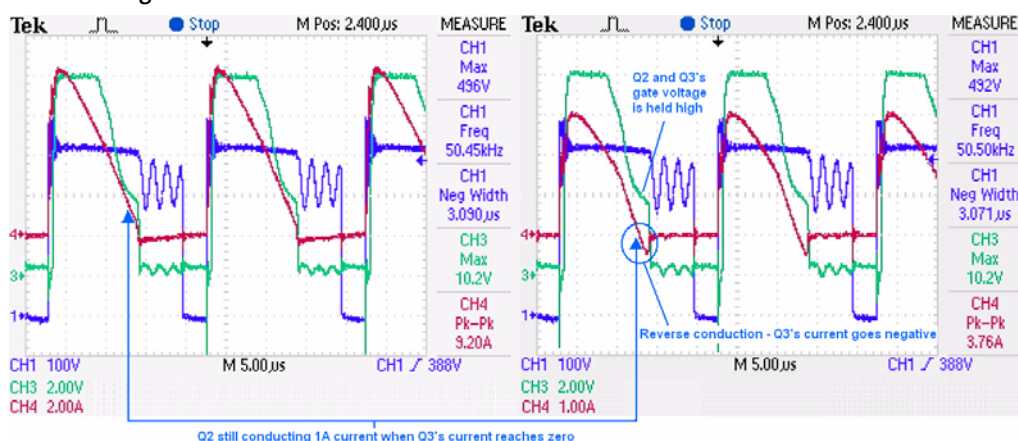
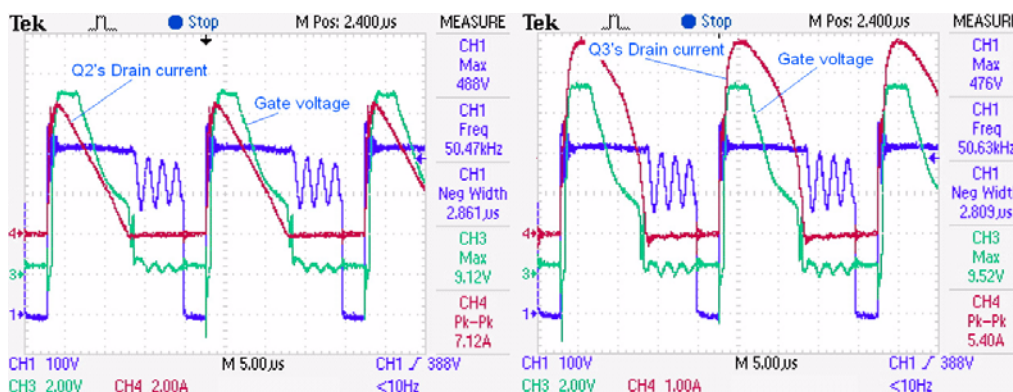

**Figure 6 - Synchronous MOSFET current and voltage waveforms for uneven output loading (CH3: Gate voltage; CH4: Drain current)**

# DN91

Subsequently, a negative current flows through Q3 and discharges the output capacitor C9. This negative or reverse current flow under uneven loading is inhibited in normal Schottky rectification because the diode acts as a unidirectional switch. In the event of reverse current flow in one of the synchronous rectified outputs, the converter will need to replenish this lost output energy through a slight increment in Q3's peak current in the next switching cycle. This maintains the same average current that goes to the 3.3V load. Nevertheless the effect of higher peak Q3 current is compensated by the use of a low on-resistance MOSFET, so the efficiency improvement over a Schottky is preserved as shown in table 2.

Figure 7 below shows Q2 and Q3's voltage and current when the 3V output is more heavily loaded than the 5V output. Although the current on the 5V output is now 1.25A compared with 2A on the 3V output, the Gate voltage is still high enough to enhance the MOSFETs



**Figure 7 - Q2 and Q3's current and voltage for 5V, 1.25A; 3.3V, 2A loads  
(CH3: Gate voltage; CH4: Drain current)**

Table 2 shows the efficiency measurement as well as output voltage regulation taken at varying load profiles. Another important aspect to be considered is the effect of synchronous rectification on the power supply cross regulation performance. The regulation on the more critical 5V and 3.3V outputs are within  $\pm 3\%$  under the considered conditions. Generally flyback converters have fairly poor regulation at lighter load, which could be improved with a few mW of dummy load resistor on the affected output.

**Table 2 – Synchronous rectification's efficiency vs. loading profile**

Loading profile	5V		3.3V		12V		-20V		Pout (W)	Efficiency (%)
	(V)	(A)	(V)	(A)	(V)	(A)	(V)	(mA)		
1	5.03	3.25	3.28	2.5	12.03	0.5	-19.30	60	31.7	77.4
2	5.05	2.5	3.32	2	12.03	0.5	-20.30	60	26.5	78.2
3	5.07	2.5	3.40	1	12.08	0.5	-20.52	60	23.4	77.4
4	5.11	1.25	3.18	2	12.14	0.5	-20.72	60	20.06	77.0
5	5.13	1.25	3.54	1	12.16	0.125	-21.6	20	11.9	73.9

Efficiency results in the previous section show that synchronous rectification can yield more than a 3% better efficiency than diodes in multiple output flyback converters suitable for set top boxes. This improvement is attributed to the significant conduction loss saving from the MOSFETs.

Another observation is that the synchronous rectified power supply will consume more power at low load. Its standby power consumption to produce 1W on output is approximately 1W higher than that of Schottky solution as shown in Figure 8. This increased low load power is due to the accumulation of losses associated with synchronous MOSFET's gate charge loss and power consumption of the ZXGD3101.

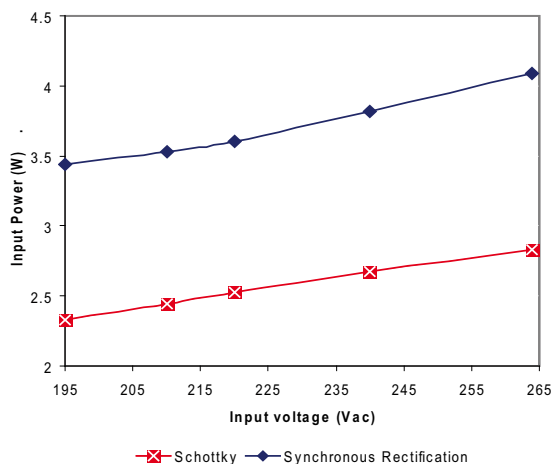

**Figure 8 - Required input power to maintain 1W output**

## Conclusion

Low side synchronous rectification has been examined on a multiple output flyback converter suitable for use as a set top box power supply. The proposed configuration allows two synchronous MOSFETs to be driven by a common ZXGD3101 controller. The main control loop is closed around the 5V output of the set top box power supply and a stacked winding is employed to ensure a manageable transformer design as well as achieving a satisfactory cross regulation performance.

The experimental four output set top box power supply manages to achieve more than 78% efficiency when Schottky diodes on the low voltage outputs are replaced with low resistance MOSFETs. PC board could now be used to provide heat sinking, eliminating the need for an external heat sink, and also removing the cost of the heat sink and associated assembly costs.

# DN91

## Definitions

### Product change

Diodes Incorporated reserves the right to alter, without notice, specifications, design, price or conditions of supply of any product or service. Customers are solely responsible for obtaining the latest relevant information before placing orders.

### Applications disclaimer

The circuits in this design/application note are offered as design ideas. It is the responsibility of the user to ensure that the circuit is fit for the user's application and meets with the user's requirements. No representation or warranty is given and no liability whatsoever is assumed by Diodes Inc. with respect to the accuracy or use of such information, or infringement of patents or other intellectual property rights arising from such use or otherwise. Diodes Inc. does not assume any legal responsibility or will not be held legally liable (whether in contract, tort (including negligence), breach of statutory duty, restriction or otherwise) for any damages, loss of profit, business, contract, opportunity or consequential loss in the use of these circuit applications, under any circumstances.

### Life support

Diodes Zetex products are specifically not authorized for use as critical components in life support devices or systems without the express written approval of the Chief Executive Officer of Diodes Incorporated. As used herein:

A. Life support devices or systems are devices or systems which:

1. are intended to implant into the body

or

2. support or sustain life and whose failure to perform when properly used in accordance with instructions for use provided in the labelling can be reasonably expected to result in significant injury to the user.

B. A critical component is any component in a life support device or system whose failure to perform can be reasonably expected to cause the failure of the life support device or to affect its safety or effectiveness.

### Reproduction

The product specifications contained in this publication are issued to provide outline information only which (unless agreed by the company in writing) may not be used, applied or reproduced for any purpose or form part of any order or contract or be regarded as a representation relating to the products or services concerned.

### Terms and Conditions

All products are sold subjects to Diodes Inc terms and conditions of sale, and this disclaimer (save in the event of a conflict between the two when the terms of the contract shall prevail) according to region, supplied at the time of order acknowledgement.

For the latest information on technology, delivery terms and conditions and prices, please contact your nearest Diodes Inc. sales office .

### Quality of product

Diodes Zetex Semiconductors Limited is an ISO 9001 and TS16949 certified semiconductor manufacturer.

To ensure quality of service and products we strongly advise the purchase of parts directly from Diodes Zetex Semiconductors or one of our regionally authorized distributors. For a complete listing of authorized distributors please visit: [www.diodes.com](http://www.diodes.com). Diodes Zetex Semiconductors does not warrant or accept any liability whatsoever in respect of any parts purchased through unauthorized sales channels.

### ESD (Electrostatic discharge)

Semiconductor devices are susceptible to damage by ESD. Suitable precautions should be taken when handling and transporting devices. The possible damage to devices depends on the circumstances of the handling and transporting, and the nature of the device. The extent of damage can vary from immediate functional or parametric malfunction to degradation of function or performance in use over time. Devices suspected of being affected should be replaced.

### Green compliance

Diodes Zetex Semiconductors is committed to environmental excellence in all aspects of its operations which includes meeting or exceeding regulatory requirements with respect to the use of hazardous substances. Numerous successful programs have been implemented to reduce the use of hazardous substances and/or emissions.

All Diodes Zetex components are compliant with the RoHS directive, and through this it is supporting its customers in their compliance with WEEE and ELV directives.

### Product status key:

"Preview"	Future device intended for production at some point. Samples may be available
"Active"	Product status recommended for new designs
"Last time buy (LTB)"	Device will be discontinued and last time buy period and delivery is in effect
"Not recommended for new designs"	Device is still in production to support existing designs and production
"Obsolete"	Production has been discontinued

### Datasheet status key:

"Draft version"	This term denotes a very early datasheet version and contains highly provisional information, which may change in any manner without notice.
"Provisional version"	This term denotes a pre-release datasheet. It provides a clear indication of anticipated performance. However, changes to the test conditions and specifications may occur, at any time and without notice.
"Issue"	This term denotes an issued datasheet containing finalized specifications. However, changes to specifications may occur, at any time and without notice.

## Sales offices

The Americas	Europe	Taiwan	Shanghai	Shenzhen	Korea
3050 E. Hillcrest Drive Westlake Village, CA 91362-3154 Tel: (+1) 805 446 4800 Fax: (+1) 805 446 4850	Kustermann-Park Balanstraße 59, D-81541 München Germany Tel: (+49) 894 549 490 Fax: (+49) 894 549 4949	7F, No. 50, Min Chuan Road Hsin-Tien Taipei, Taiwan Tel: (+886) 289 146 000 Fax: (+886) 289 146 639	Rm. 606, No.1158 Changning Road Shanghai, China Tel: (+86) 215 241 4882 Fax (+86) 215 241 4891	ANLIAN Plaza, #4018 Jintian Road Futian CBD, Shenzhen, China Tel: (+86) 755 882 849 88 Fax: (+86) 755 882 849 99	6 Floor, Changhwa B/D, 1005-5 Yeongtong-dong, Yeongtong-gu, Suwon-si, Gyeonggi-do, Korea 443-813 Tel: (+82) 312 731 884 Fax: (+82) 312 731 885