

General Description

This demonstration board utilizes the AL16937 Buck LED driver providing a cost effective triac dimmable solution for offline high brightness LED applications. This user-friendly evaluation board provides users with quick connection to their different types of LEDs string. The demonstration board can be modified easily to adjust the LED output current and the number of series connected LEDs that are driven.

A BOM, schematic and layout are included that describes the parts used on this demonstration board, along with measured performance characteristics. These materials can be used as a reference design.

Key Features

- Triac Dimmable
- Active PFC with power factor >0.92
- High efficiency >88%
- Single winding
- Good dimmer compatibility
- Low BOM cost

Applications

- Retrofit Bulb, Par lamps

Specifications

Parameter	Value
AC Input Voltage	108~132V
Output Power	6.75W
LED Current	150mA
LED Voltage	45V
Power Factor	>0.92
Efficiency	88%
XYZ Dimension	49 x 35x15mm
ROHS Compliance	Yes

Evaluation Board

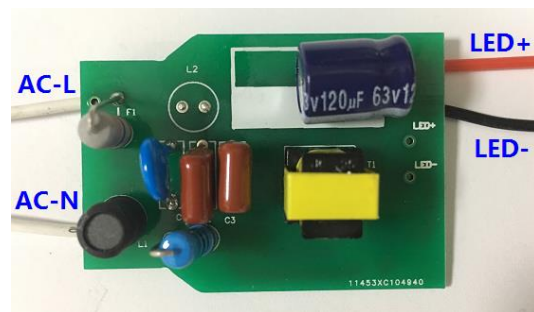

Figure 1: Top View

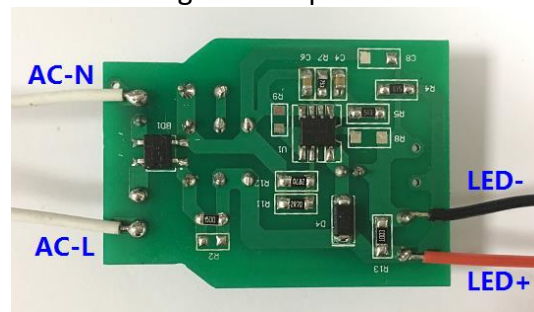

Figure 2: Bottom View

Connection Instructions:

- AC-L Input: White – Hot
- AC-N Input: White– Neutral
- DC LED+ Output: LED+ (Red)
- DC LED- Output: LED- (Black)

Board Layouts

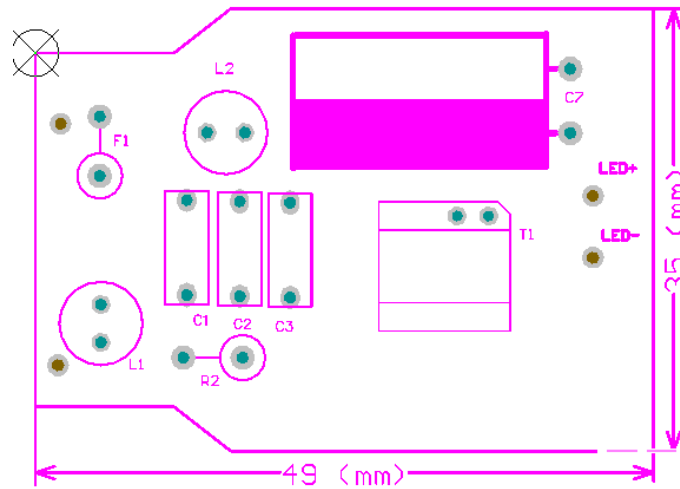

Figure 3: PCB Layout Top View

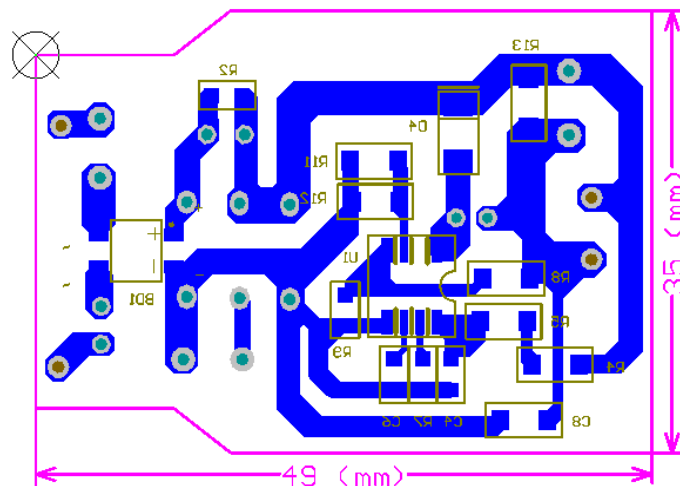

Figure 4: PCB Layout Bottom View

Quick Start Guide

1. Preset the isolated AC source to 120VAC.
2. Ensure that the AC source is switched OFF or disconnected.
3. Connect the anode wire of the LED string to the LED+ terminal of the evaluation board.
4. Connect the cathode wire of the LED string to the LED- terminal of the evaluation board.
5. Connect two AC line wires to the AC-L and AC-N terminals on the evaluation board.
6. Ensure that the area around the board is clear and safe, and preferably that the board and LEDs are enclosed in a transparent safety cover.
7. Turn on the main switch. LED string should light up with LED.
DO NOT TOUCH THE BOARD, LEDs OR BARE WIRING.

Caution: The AL16937 is a non-isolated design. All terminals carry high voltage during operation!

Schematic

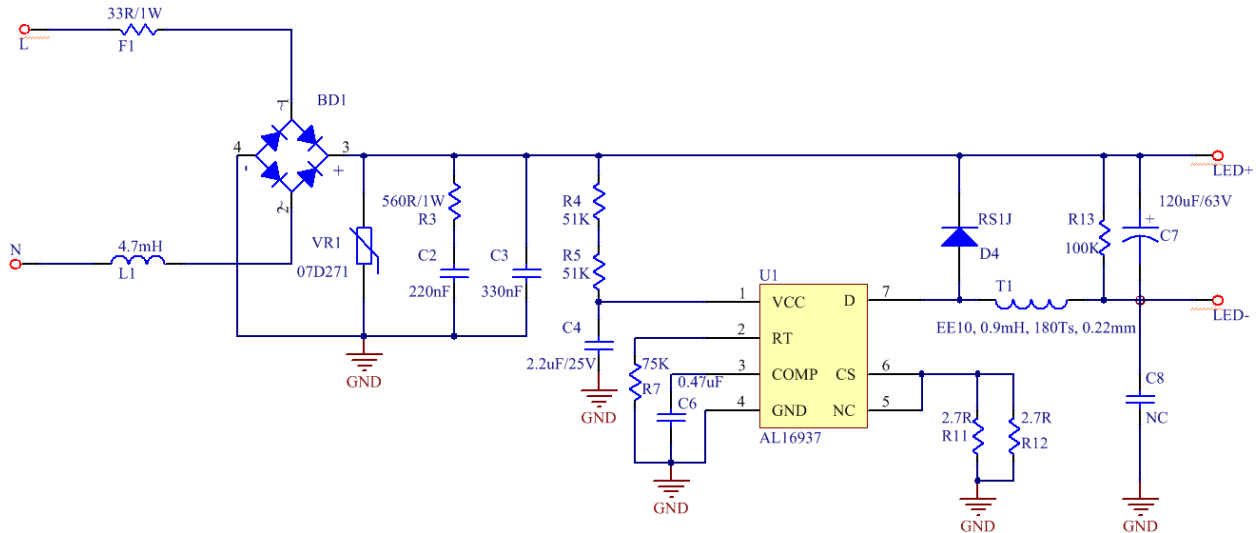

Figure 5: Schematic Circuit

Transformer Design

Bobbin and Core

EE10 Vertical 4+4 pin

Transformer Parameters

1. Primary Inductance (Pin2-Pin1): $L_p=0.9\text{mH}$, $\pm 5\%$ @10kHz
2. Primary Winding Turns (Pin 2-Pin 1): $N_p=180\text{Ts}$

Transformer Winding Construction Diagram

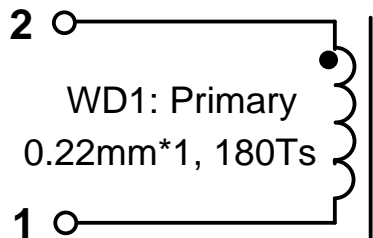

Item	Winding name	Description
1	WD1-Primary Winding	Start at Pin2, Wind 180 turns of $\Phi 0.22\text{mm}$ wire and finish on Pin1.
2	Insulation	3 Layers of insulation tape

Bill of Material

No.	Item	Description	Package	Quantity
1	VR1	Varistor, 07D271	DIP	1
2	C2	220nF/250V, CL21, Pitch=7.5mm	DIP	1
3	C3	330nF/250V, CL21, Pitch=7.5mm	DIP	1
4	C4	Ceramic Cap, 2.2uF/25V, X7R	C0805	1
5	C8	NC	C1206	0
6	C6	Ceramic Cap, 0.47uF/16V, X7R	C0805	1
7	C7	E-Cap, 105°C, 120uF/63V, 10*12.5mm	DIP	1
8	R3	Power Resistor, 560R, 5%, 1W	DIP	1
9	R4, R5	SMD Resistor, 51K, 5%, 1/4W	R1206	2
10	R7	SMD Resistor, 75K, 5%, 1/8W	R0805	1
11	R11, R12	SMD Resistor, 2R7, 1%, 1/8W	R1206	2
12	R13	SMD Resistor, 100K, 5%, 1/4W	R1206	1
13	F1	Fuse Resistor, 33R, 5%, 1W	DIP	1
14	D4	Diode, RS1J, 1A/600V, Diodes Inc	SMA	1
15	BD1	Rectifier Bridge, MB10S, 1A/1000V, Diodes Inc	MBS	1
16	L1	Drum Inductor 3.3mH, 6*8mm	DIP	1
17	T1	EE10, Vertical, 4+4 pin, 0.9mH	DIP	1
18	U1	AL16937-30BAS7-13-N1, Diodes Inc	SOP7	1
Total				19

Electrical Performance

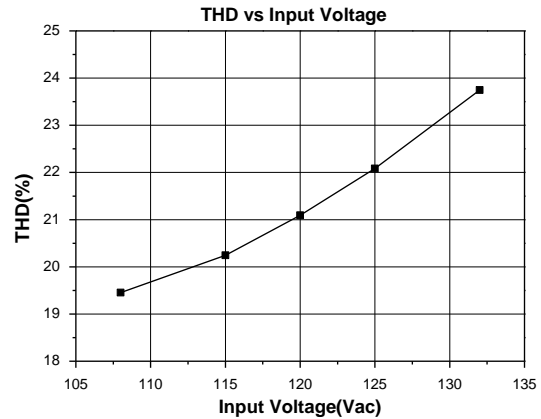
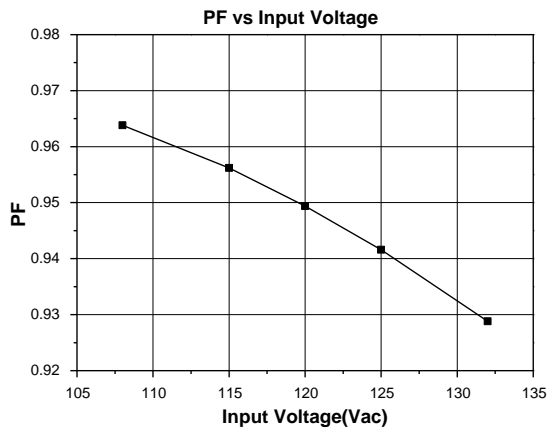
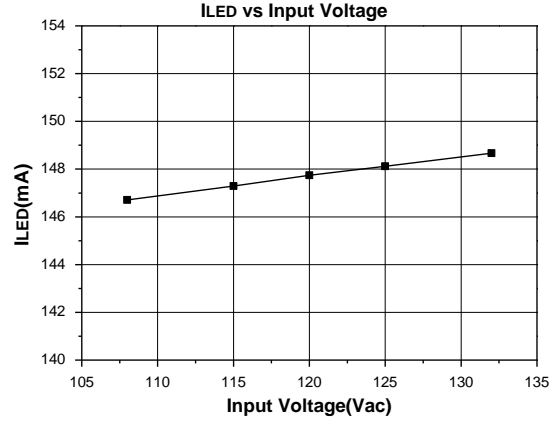
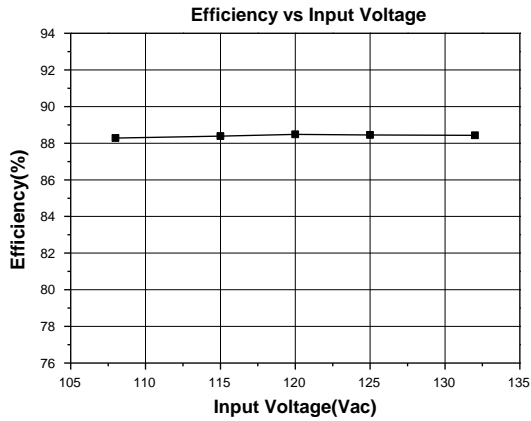

Dimming Test

Dimmer compatibility and dimming range

Num	Dimmer Type	I _{LED} (mA)		Dimming Percentage(%)		Flicker or not
		Min	Max	Min	Max	
1	Cooper 9539 L	8.1	130.0	5.49	88.08	No
2	Cooper SI06P L	3.0	145.2	2.03	98.37	No
3	Cooper SI061 L	3.0	147.5	2.03	99.93	No
4	Cooper TAL06P L	16.2	146.6	10.98	99.32	No
5	Cooper DLC03P L	20.0	146.4	13.55	99.19	No
6	Lutron TT-300 L	0.9	144.0	0.61	97.56	No
7	Leviton TBL03 L	9.0	146.9	6.10	99.53	No
8	ZING EAR ZE-04 L	2.0	146.7	1.36	99.39	Shimmer
9	Westek 4010 L	1.9	145.9	1.29	98.85	No
10	Leviton 6681 L	0.8	146.7	0.54	99.39	No
11	Leviton 6602 L	0.8	146.8	0.54	99.46	No
12	Leviton 6631 L	4.0	144.9	2.71	98.17	No
13	Leviton IPE04 T	51.5	147.3	34.89	99.80	No
14	Leviton VPE04 T	14.5	147.4	9.82	99.86	No
15	Leviton VPE06 T	13.8	147.4	9.35	99.86	No
16	Lutron DV-10P L	10.6	146.6	7.18	99.32	Shimmer
17	Lutron DVLV-10P L	9.7	144.1	6.57	97.63	No
18	Lutron DV-603P L	6.4	141.4	4.34	95.80	No
19	Lutron DVCL-153P L	5.5	142.6	3.73	96.61	No
20	Lutron N-600 L	1.1	140.5	0.75	95.19	Shimmer
21	Lutron NT-600 L	7.0	145.2	4.74	98.37	No
22	Lutron TG-600P-AC L	8.9	145.2	6.03	98.37	No
23	Lutron CT-603PG L	5.1	145.0	3.46	98.24	No
24	Lutron CTCL-153P L	5.7	106.2	3.86	71.95	No
25	Lutron NT-600L 600W	1.2	141.4	0.81	95.80	No

Functional Waveform

Input Voltage & Input Current
($V_{in}=120V_{AC}/60Hz$)

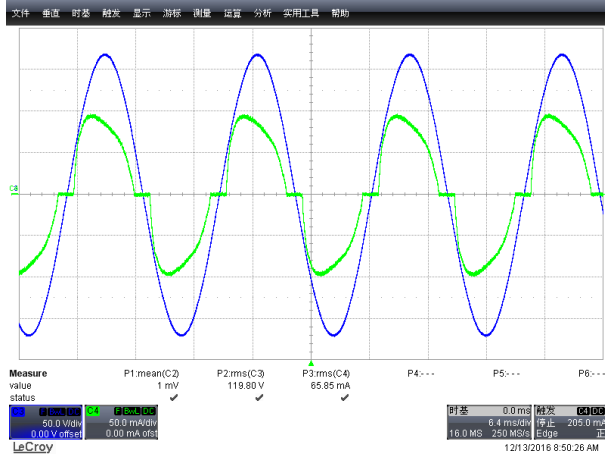

LED Current Ripple
($V_{in}=120V_{AC}/60Hz$, Ripple=101mA)

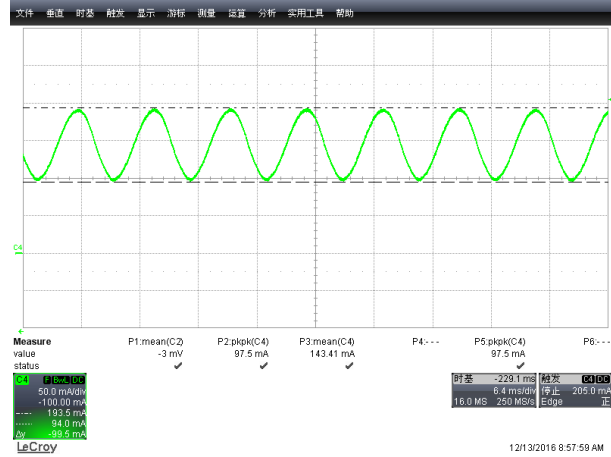

Input AC Current vs Dimmer Phase
($V_{in}=120V_{AC}/60Hz$, Conduction Angle 110deg)

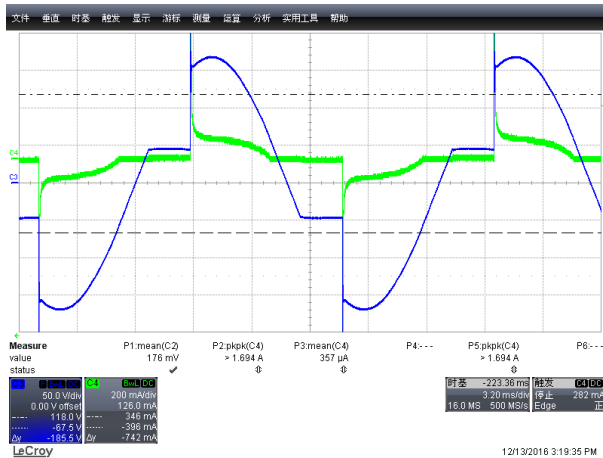

Input AC Current vs Dimmer Phase
($V_{in}=120V_{AC}/60Hz$, Conduction Angle 90deg)

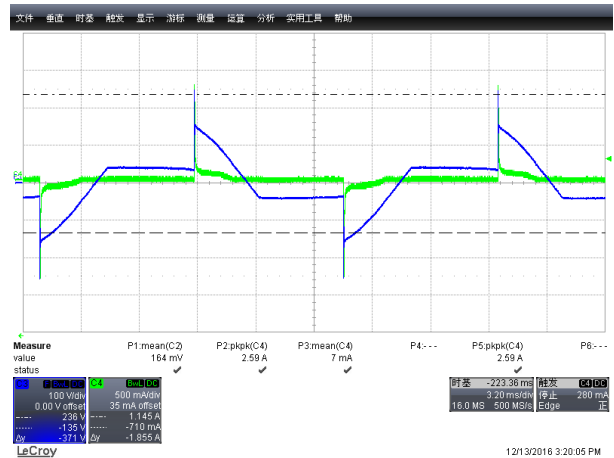

Start-up time
(Vin=108V_{AC}/60Hz, Start-up time=338ms)

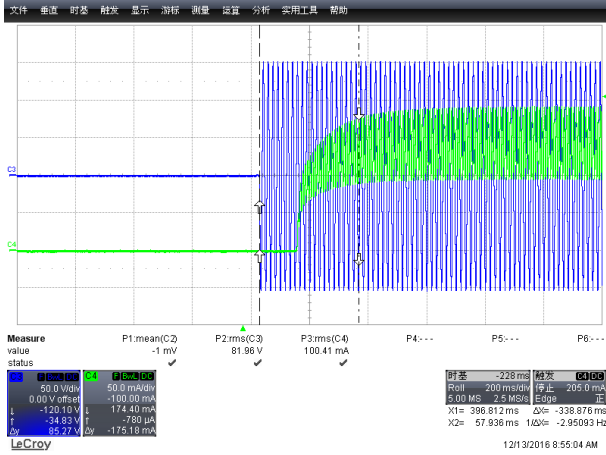

LED Short Protection
(Vin=120V_{AC}/60Hz, Y-V_{cc}, R-CS, G-I_{LED})

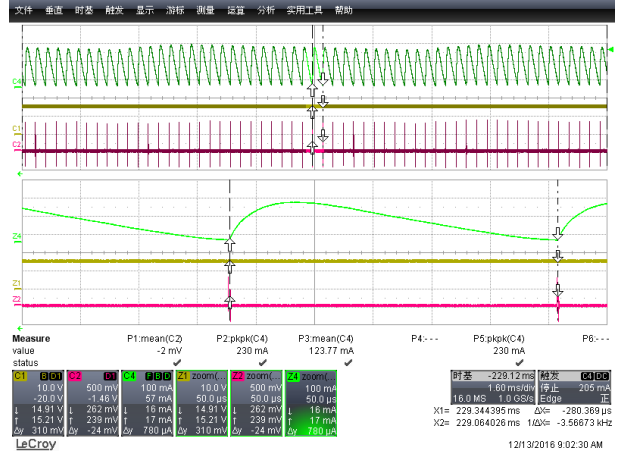

Thermal Test

Top
(Vin=120V_{AC}, Burn-in time=60min)

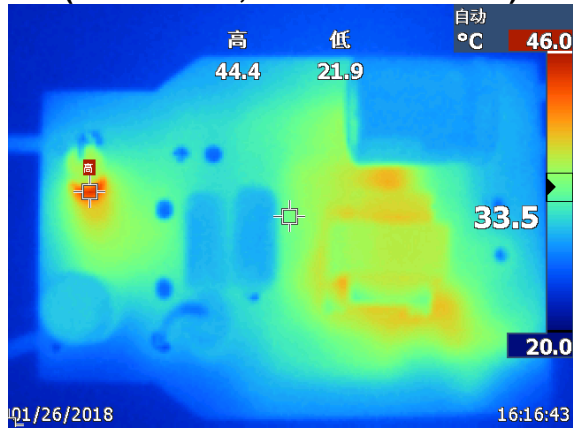

Bottom
(Vin=120V_{AC}, Burn-in time=60min)

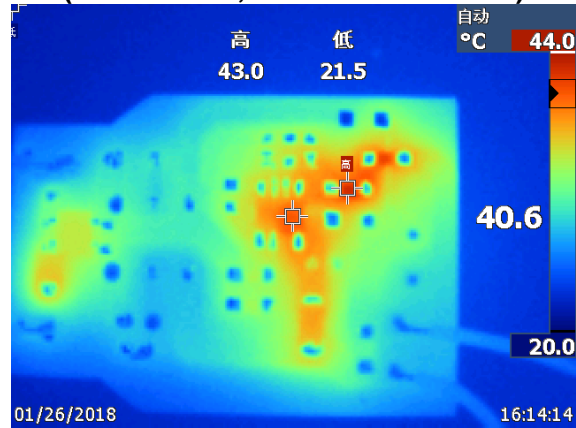

EMI Conduction Test

Line Terminal
(Vin=120VAC, Margin>4dB)

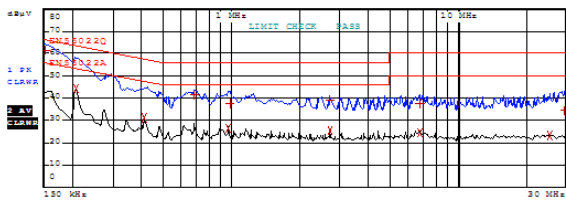
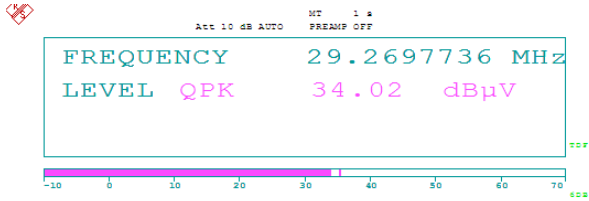

EDIT PEAK LIST (Final Measurement Results)			
TRACE	FREQUENCY	LEVEL dBμV	DELTA LIMIT dB
1 Quasi Peak	151.5 kHz	61.71	-4.19
2 Average	208.24110178 kHz	44.17	-9.18
2 Average	408.778285137 kHz	31.12	-16.32
1 Quasi Peak	680.673428436 kHz	41.19	-14.90
2 Average	834.698682378 kHz	24.26	-19.73
1 Quasi Peak	882.628047757 kHz	37.85	-18.13
1 Quasi Peak	2.71400741499 MHz	38.98	-17.03
2 Average	2.71400741499 MHz	28.36	-20.43
1 Quasi Peak	6.71208330694 MHz	37.46	-22.33
2 Average	6.71208330694 MHz	24.73	-25.26
2 Average	28.2118041866 MHz	23.33	-26.66
1 Quasi Peak	29.2697736439 MHz	34.47	-23.22

Neutral Terminal
(Vin=120VAC, Margin>4dB)

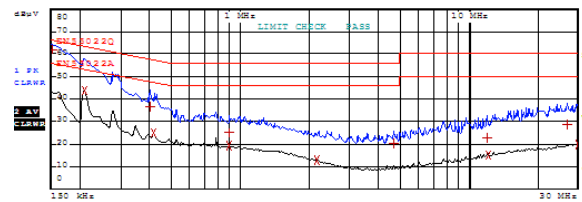
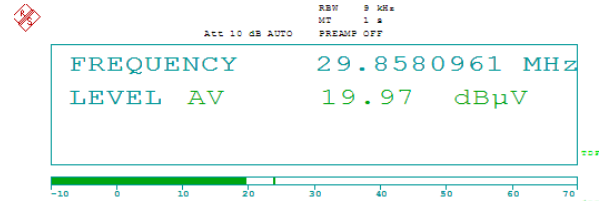

EDIT PEAK LIST (Final Measurement Results)			
TRACE	FREQUENCY	LEVEL dBμV	DELTA LIMIT dB
1 Quasi Peak	151.5 kHz	61.82	-4.09
2 Average	208.202512797 kHz	43.91	-9.36
1 Quasi Peak	401.708024172 kHz	36.76	-21.05
2 Average	412.877088109 kHz	24.83	-22.73
1 Quasi Peak	890.465639804 kHz	24.91	-31.08
2 Average	890.465639804 kHz	19.27	-26.72
2 Average	2.1374603093 MHz	12.64	-33.35
1 Quasi Peak	4.64478070168 MHz	20.23	-33.73
1 Quasi Peak	11.8325178476 MHz	22.67	-37.32
2 Average	12.073052723 MHz	15.19	-34.80
1 Quasi Peak	26.7625196891 MHz	28.96	-31.03
2 Average	29.8580960942 MHz	19.93	-30.06

IMPORTANT NOTICE

DIODES INCORPORATED MAKES NO WARRANTY OF ANY KIND, EXPRESS OR IMPLIED, WITH REGARDS TO THIS DOCUMENT, INCLUDING, BUT NOT LIMITED TO, THE IMPLIED WARRANTIES OF MERCHANTABILITY AND FITNESS FOR A PARTICULAR PURPOSE (AND THEIR EQUIVALENTS UNDER THE LAWS OF ANY JURISDICTION).

Diodes Incorporated and its subsidiaries reserve the right to make modifications, enhancements, improvements, corrections or other changes without further notice to this document and any product described herein. Diodes Incorporated does not assume any liability arising out of the application or use of this document or any product described herein; neither does Diodes Incorporated convey any license under its patent or trademark rights, nor the rights of others. Any Customer or user of this document or products described herein in such applications shall assume all risks of such use and will agree to hold Diodes Incorporated and all the companies whose products are represented on Diodes Incorporated website, harmless against all damages.

Diodes Incorporated does not warrant or accept any liability whatsoever in respect of any products purchased through unauthorized sales channel.

Should Customers purchase or use Diodes Incorporated products for any unintended or unauthorized application, Customers shall indemnify and hold Diodes Incorporated and its representatives harmless against all claims, damages, expenses, and attorney fees arising out of, directly or indirectly, any claim of personal injury or death associated with such unintended or unauthorized application.

Products described herein may be covered by one or more United States, international or foreign patents pending. Product names and markings noted herein may also be covered by one or more United States, international or foreign trademarks.

LIFE SUPPORT

Diodes Incorporated products are specifically not authorized for use as critical components in life support devices or systems without the express written approval of the Chief Executive Officer of Diodes Incorporated. As used herein:

A. Life support devices or systems are devices or systems which:

1. are intended to implant into the body, or
2. support or sustain life and whose failure to perform when properly used in accordance with instructions for use provided in the labeling can be reasonably expected to result in significant injury to the user.

B. A critical component is any component in a life support device or system whose failure to perform can be reasonably expected to cause the failure of the life support device or to affect its safety or effectiveness.

Customers represent that they have all necessary expertise in the safety and regulatory ramifications of their life support devices or systems, and acknowledge and agree that they are solely responsible for all legal, regulatory and safety-related requirements concerning their products and any use of Diodes Incorporated products in such safety-critical, life support devices or systems, notwithstanding any devices- or systems-related information or support that may be provided by Diodes Incorporated. Further, Customers must fully indemnify Diodes Incorporated and its representatives against any damages arising out of the use of Diodes Incorporated products in such safety-critical, life support devices or systems.

Copyright © 2015, Diodes Incorporated

www.diodes.com